

The Contractors Handbook on Indiana Limestone

For Contractors,
Masons and
Erectors
7th Edition

Indiana
Limestone
Institute

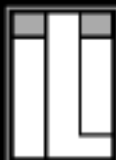

The coordinating agency
for information, education,
and technical data for
Indiana Limestone, the
Nation's Building Stone.



Chipped stones may be useable. Will the chips cover? Are they on the back? Can the stone be cut down and used elsewhere?



When unloading using slings, stack stones back to back, or insert padding between them to avoid chips from bumping.



Pad stone edges under slings to avoid compression chips.

checklist

The following is a list of procedures which will aid in satisfactory performance and trouble reduction. Also, post the folder HOW TO RECEIVE, UNLOAD, STORE, AND HANDLE INDIANA LIMESTONE at the jobsite.

A. Upon delivery of materials:

1. Check for damage—cracked, chipped or broken pieces.
2. Verify proper stone—color, finish, grade.
3. Verify identification marking, dimensions, anchor locations.
4. Store in protected area, off ground.

B. Before starting stonework:

1. Storage. DISCARD SHIPPING DUNNAGE. Use sturdy pallets or A-frames. Stack or lean stone panels with spacers so that air can circulate. Use half-ball nylon pads. Pine spacers can be used. They should be as small a size as will support the weight.
2. Observe cold-weather setting procedures as required. See p. 8, 9.
3. Verify correct positioning and size of backup or framing and support.
4. Verify installation of dampproofing and flashing.

C. Mortar:

1. Verify that materials meet the standards specified.
2. Check mixing procedure for proper proportions of ingredients and mixing time.
3. Use mixed mortar within time specified.

D. Metal accessories and anchors:

1. Verify that materials meet the standards specified.
2. Corrosion resistance requirements must be met.
3. Size and configuration of accessories must allow for proper adjustment.



A messy, disorganized stacking yard like this will cost you money, time and trouble. Keep stone stacked neatly, and in setting sequence.

E. Stone erection or placement:

1. Stone laid in mortar.
 - a. Weepholes at base of walls and over openings.
 - b. Full mortar joints.
 - c. No mortar droppings in air space between backup and stone.
 - d. Uniform mortar joint width.
 - e. Proper bond pattern of stone.
 - f. Cover tops of walls overnight, weekends, and when raining during work hours.
2. Stone set with shims or support frames.
 - a. Connections conform to detail drawings.
 - b. Remove temporary setting pads for soft joints between cut stone pieces.
 - c. Soft joint between building frame and stone.
 - d. In setting with shims, make sure sufficient shim material is placed to avoid point-loading the stone.
3. Cover top of walls when rain is expected.
4. Verify proper horizontal and vertical alignment.
5. Keep wall clean.

handling cautions

1. Be careful not to bump stones, or to let a stone bump support angles, structure, etc. Position stones accurately above supports, and lower them slowly into place to avoid damaging support surfaces or angle pockets.
2. When lifting stones, make certain that all personnel are clear.

NEVER HOIST OR SUSPEND STONES OVER WORKMEN OR BYSTANDERS. IF STONES MUST BE HOISTED OVER SCAFFOLDS OR STAGES, WORKMEN MUST BE CLEAR, ALL WORKMEN ON SCAFFOLDS MUST WEAR SAFETY LINES. SEE TECHNICAL NOTE ON LEWIS LIFTING DEVICES AT BACK OF THIS BOOKLET.

3. Make certain that all lifting devices, and all parts involved with hoisting machines, are of sufficient capacity for the heaviest stone to be lifted.
4. Observe special caution in rigging, handling and lifting large panels. Windy conditions require precautions as well. Use tag lines, and make certain that operators are instructed in their proper use.
5. **ALWAYS USE SAFETY SLINGS UNDER STONES AS YOU LIFT THEM, AND KEEP SLINGS IN PLACE UNTIL STONES ARE WITHIN A FEW INCHES OF THEIR FINAL LOCATION.**
6. Where it might be possible for anchors which cross joints to bottom in anchor slots or holes, place a compressible material at the bottom of the slot or hole. Make certain that mortar placed in anchor holes does

not pile up and defeat the intent of soft joints by filling the joint space behind the sealant and backer rod.

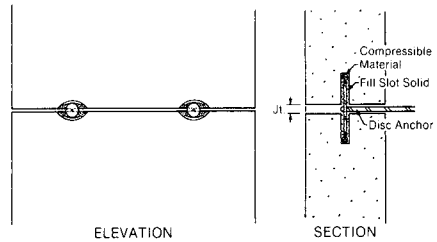

7. **NEVER** pour concrete against unprotected or unbraced Indiana Limestone.
8. Observe Cold Weather Masonry Procedures when necessary. See p. 8, 9.
9. It is usually safer to make mortar too lean rather than too rich.
10. Reseal pierced flashing.
11. Tall vertical joints are likely to fail. Use joint sealant, particularly at column covers and quirk miters.
12. Don't use accelerators or retarders in mortar. **NEVER FILL ANCHOR HOLES OR SLOTS WITH HIGH-STRENGTH OR EXPANDING GROUT.**
13. Protect finished work against construction traffic. Drape or pile sand on projecting courses to protect against mortar droppings.

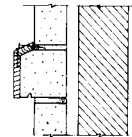

14. **ALWAYS COVER TOPS OF UNFINISHED WALLS, AND PROTECT UNGLAZED WINDOW OPENINGS, IN RAINSTORMS AND OVERNIGHT.**
15. See pages 11, 12, and 13 for stain-avoidance procedures.
16. Display the ILI poster "How to Receive, Unload, Store and Handle Indiana Limestone."



If you MUST use pinch bars, either pad the stone, or make sure the chipped edges will cover.

receiving, storing and handling guide

As a general rule, handle stone with the same care you would use to handle any material you don't want to chip or scratch. Store it on sturdy skids or timbers in well-drained space, gravelled or chipped for protection against mud splatters. Plan storage so that stones will be easily available to your handling equipment when they're needed. It isn't necessary to protect the stacks from rain, but if you foresee extended storage, covering the stacks with poly or waterproof paper will protect them; permit air circulation. Check your pallets and A-frames from time to time to make sure they aren't twisting or collapsing.

Lean smooth-finish stones face to face and back to back. Textured finishes should be separated with spacers.

When lifting, avoid sliding one face surface over another. Make sure lifting holes are easily reached from the stacked position.

The dunnage material used by limestone suppliers *IS NOT* intended for long-term storage. Discard it, and use non-absorbent plastic, or half-ball pads.

Unless other arrangements are made, your stone supplier will expect his A-frame and other specifically-made transportation aids to be returned within a reasonable time. The supplier may be willing to loan such aids for your long-term use, but you must make arrangements for that with him.

See inside front cover for a checklist outlining other steps toward a trouble-free project.

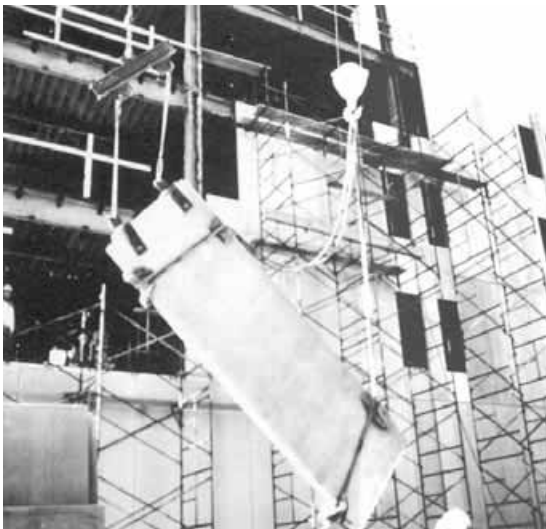
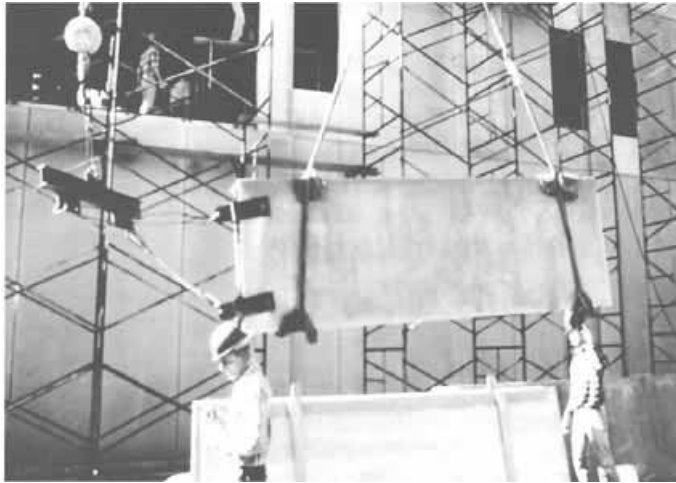
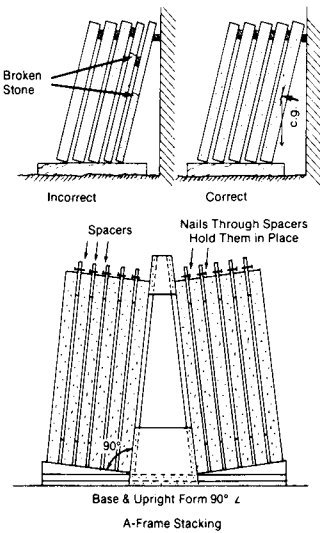

Turning a large panel in the air requires a crane with double mainfalls. This maneuver saves stacking space and reduces handling.

lifting devices

Holes and sinkages for attaching the stone to the building will be as shown on the shop drawings, but you must make arrangements for any specific sinkages you need for your job site handling. If you don't, the supplier will cut only those sinkages he needs for his own equipment.

Slings are the preferred handling tools for most applications. Make sure they are long and wide enough — too short, or too narrow, and they will tend to pinch stone arrises.

If you plan to use clamps or lewis devices, your stone supplier can give you the names of manufacturers of these appliances.

Devices attached at or near the tops of stone panels should not be used to raise the panels from a horizontal position.

ALWAYS use safety slings when lifting stones using lewis or other metal devices. NEVER use lewis devices to lift stones less than 3" thick. Lewis pins are particularly treacherous when incorrectly used. ILI Technote on Stone Handling — Lifting with Lewis Pins, is reprinted at the back of this book. Individual copies available on request.

FAILURE LOADS (P)

| Pin Size | Hole Diam | Hole Angle (A) | Max. Load at Fracture or Pin-Bend |
|---------------|-----------|----------------|-----------------------------------|
| 1" x 6" | 1-1/4" | 18-20 deg. | 12,300 lbs. |
| do. | do. | 25-30 deg. | 10,400 lbs. |
| 3/4" x 5 1/2" | 7/8" | 25 deg. | 7,660 lbs. |
| 1/2" x 5" | 3/8" | 25 deg. | 3,500 lbs. |

The values shown here are actual failure loads of specific stones and rigging arrangements. Other stones and arrangements tested in the same manner may not produce the same failure values. A generous safety factor **MUST** be applied to failure loads when determining safe lifting capacities.

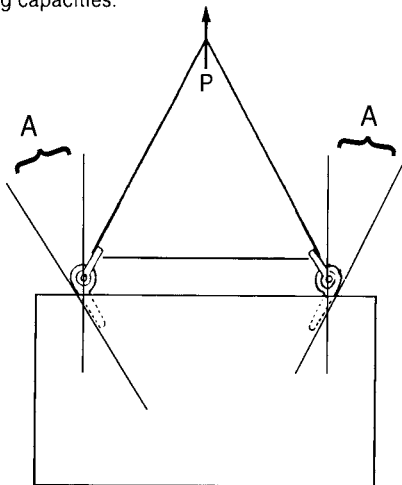

ALL THREE SIDES OF TRIANGLE SHOULD BE EQUAL

Slings

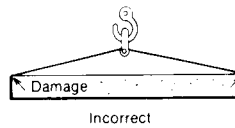

Too-short slings cause damage at stone edges. Loads lifted by such slings tend to be unstable.

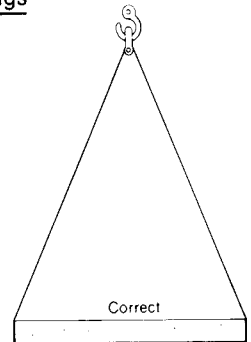

Lifting Pulley allows self-leveling of stone.

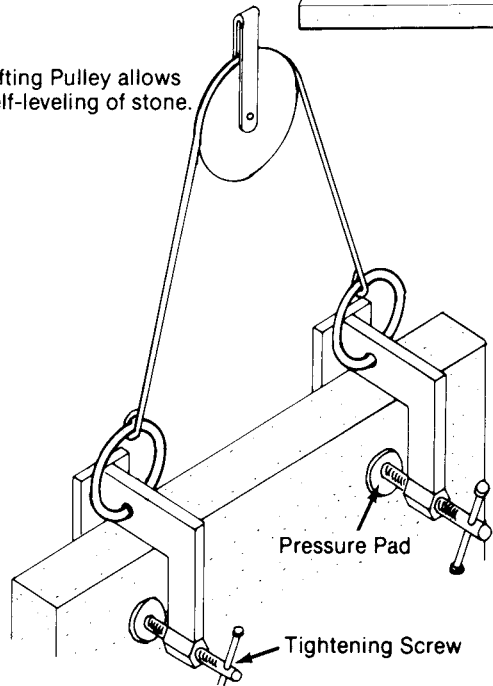

Lifting stone panels from horizontal to vertical with clamp or other top-attachment can cause breakage and injury.

Note: Always use safety slings under stones held or lifted by devices attached to their tops or top edges. Keep slings in place until stones are at or near their final installation position.

anchor and anchoring practice

A contract for Indiana Limestone will ordinarily exclude anchoring devices and support steel. Sometimes the specifications will direct a particular trade or contractor to provide them. In any case, when the stone supplier shows anchors on his shop drawings, he is not necessarily proposing to furnish them. (However, he or ILI will be glad to name suppliers of these items to a prospective purchaser.) An exception to this rule is the steel required in the assembly of multiple-stone units which are preassembled and shipped as units to the job. This distinction is ordinarily made in specifications by the architect, and in any case will be shown on the shop drawings.

In general, an "anchor" is any device which attaches stone to structure or stone to stone but is not load-bearing. Anchors are typically not loaded except by wind or other lateral force. "Support steel" is expected to bear the weight of a stone or stones. Support steel is typically a series of clips or continuous angles, with or without bars or blades on the nose for lateral restraint.

Anchors should be Stainless Steel.

The recommended minimum sizes shown are for general information only. The proper size and type of anchor for each specific condition depends upon design loads and specification requirements. The correct anchor type and size should be determined by engineering analysis.

Any anchor or other metal to be inserted in slots or sinkages in Indiana Limestone must be of stainless steel. Multi-part anchors may contain other metals so long as the stone-attachment portions are stainless. Where support steel is affixed in epoxy-filled slots, as is typical of preassemblies, those portions of the support which are in the stone must be stainless steel.

support systems

Support steel need not be stainless steel. A36 or other hot-formed plate or angle will perform adequately provided it is coated for protection. Hot-dip galvanized material may be used if scratches and welds are to be protected. Minimum requirements include one shop protection coat and one job-applied protection coat. Bars or blades on the angle nose must be of stainless steel.

strap anchors

(Recommended $\frac{1}{8}$ " & $\frac{3}{16}$ " x 1" or $1\frac{1}{4}$ " wide)

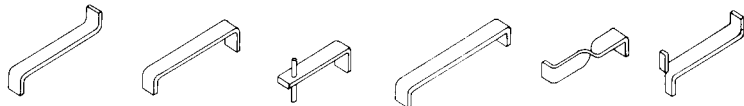

rod anchors

(Recommended $\frac{3}{8}$ " ϕ min.)

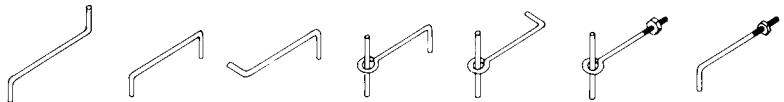

dovetail anchors

(Recommended $\frac{1}{8}$ " & $\frac{3}{16}$ " x 1" or $1\frac{1}{4}$ " wide)

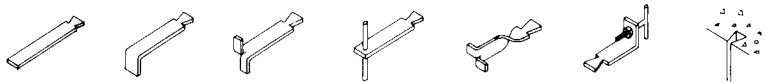

miscellaneous anchors

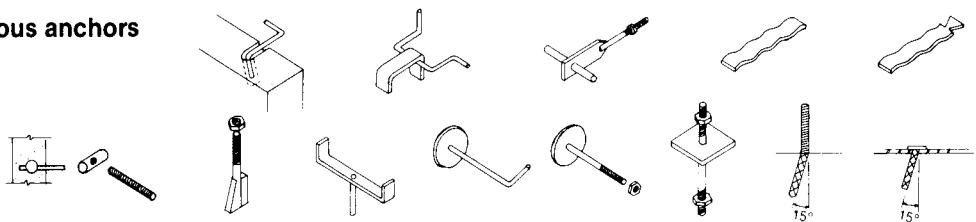

expansion anchors

follow manufacturer's recommendations on use.

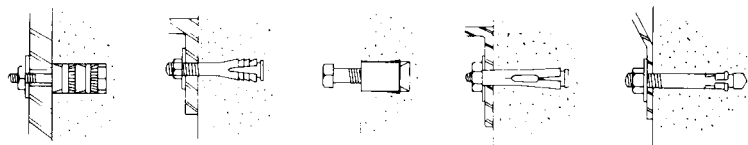

special anchors

Bracket mounted to masonry or steel

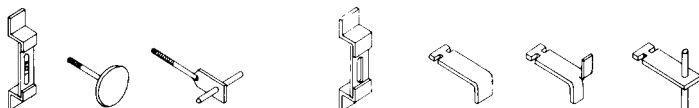

support systems

"a" & "b" Supports Above Floor

"c" & "d" Supports in Front of Floor

"e" Support Below Floor

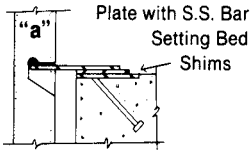

Shim

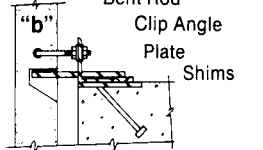

2 Nuts for Lateral Adjustment on S.S. Bent Rod

Clip Angle Plate

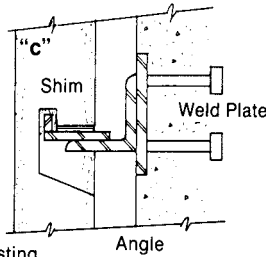
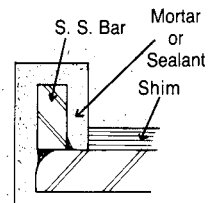

Lateral Adjusting Plate with S.S. Bar. Field Weld Plate to Angle

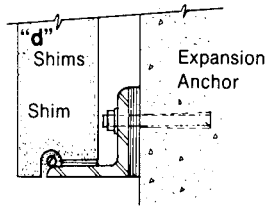
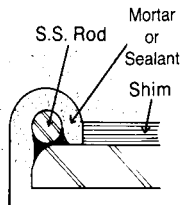

Angle with S.S. Rod

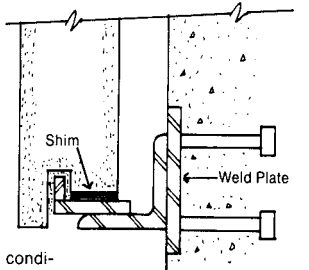
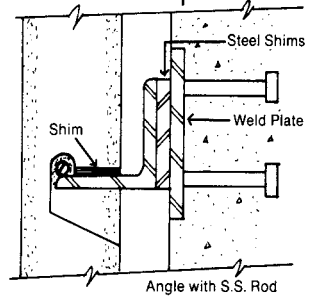
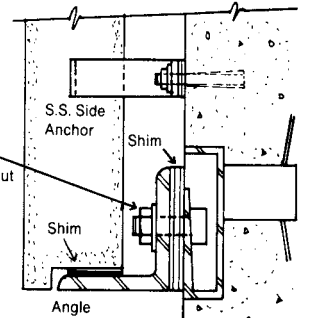
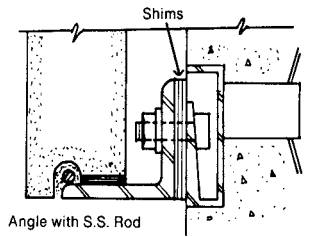

If flashing must be used in conditions similar to above, delete toe-bar or blade and install side anchor above flashing similar to "b" at left.

Lateral Adjusting Plate with S.S. Bar. Field Weld Plate to Angle

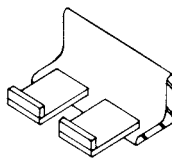

Isometric of Typical Angle with Lateral Adjusting Plates & S.S. Bars. Field Weld Plate to Angle

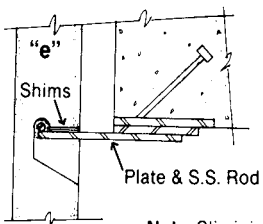

Note: Slip joints may be required in instances where floor deflection or other movement must be accommodated.

Note: Observe correct procedures in welding thin shim material to thicker weld plates.



Typical anchor placement: a Z anchor slips into anchor slots, and is secured in place with mortar. Note C clamp at right. It maintains the stone in plane while mortar sets.

joint systems

mortar setting

Portland cement used in preparing cement/lime mortar for Indiana Limestone should conform to the requirements of ASTM C-150. If masonry cement is used, it should conform to the requirements of ASTM C-91. Either material will produce a suitable mortar.

Mortars should be mixed to the proportion requirements of ASTM C270, Type N. Its compressions resistance will approximate 750 psi when cured. This moderate strength is sufficient for most limestone installation.

Portland cement/lime mortars are mixed with one part cement, one part lime and six parts sand, all by volume. (Lime improves the workability of mortar, and helps to reduce shrinkage.) This 1/1/6 mixture provides sufficient compressive strength, good bond strength and good weather resistance. The qualities of mortar can be adjusted as needed for specific applications; ASTM specifications provide guidance for needs beyond ordinary installations.

Lime should conform to ASTM C-207.

Masonry cement, sometimes called "mortar mix" or "masonry mix," ordinarily does not require the addition of lime for shrinkage resistance or for improved workability. These qualities are derived from factory-added materials which usually include an additive for air-entrainment. Masonry cement is mixed with two and one-half to three parts of sand, also by volume.

Masonry cements may be obtained which will develop the qualities described by specific ASTM indices; as in portland cement-and-lime mortars, type N for masonry cement mortars is the standard for limestone installations.

In general, a moderate strength mortar is right for Indiana Limestone. Either the 1/1/6 mix, or most prepared mortar mixes, will work. Because limestone anchoring systems are differently engineered than brick or unit masonry systems, a high-bond mortar is usually unnecessary; questions on the bond strength of mortar do not ordinarily arise.

Cements with low alkali content are called non-staining. They are best to use when setting Indiana Limestone. White cements are not necessarily either low-alkali or non-staining. The ASTM standard for low-alkali cements is C-91. To avoid staining due to alkali from mortar, wet the joint surfaces of the stone before applying mortar, and don't use too much water when mixing mortar. To avoid major staining, keep moisture out of the wall. See Item #14, p. 2. When water flows over or through concrete floors or block, and then contacts Indiana Limestone, stain can result. See p. 11 on dampproofing, and p. 17 on cleaning.

Sand should be clean and sharp and washed free of loam, silt and vegetable matter. Grading should be from fine to coarse complying with ASTM C144. If the setting mortar is to be the pointing mortar, white sand should be used.

Mixing water should be of potable quality.

Thorough mixing is necessary to develop the desirable properties of mortar. Mortar should be mixed for a five-minute period after all materials are in the mechanical mixer.

Mortar not used within two hours of initial mixing should be discarded.

If the setting mortar is to be struck or pointed to form the finished joint, the mason should leave mortar tags in place until they take their initial set. They can then be removed by brushing. Do not bag or wet-wipe the joints. Smears will result. Final cleaning should be done with fibre brushes and detergents or soap powder. High-pressure washing, using clear water at LESS THAN 1,200 psi, sprayed from a fan-shaped nozzle held no closer than 6" from the stone face, is acceptable. USE NO ACIDS FOR THIS PURPOSE, AND PROTECT THE STONE WHEN ACID-WASHING ADJACENT MATERIALS.

Most mortar coloring materials will not stain Indiana Limestone, although a sample mortar joint should be made to be sure. Colored mortars cause trouble when smeared on Limestone. Use the same cautions as with regular mortar. Cleaning colored mortar, especially where used on brick with limestone trim, can be a source of trouble. Make sure the limestone is thoroughly wet, or draped with poly, before cleaning acid flows over it. See tips on cleaning, p. 17.

The relative stiffness of the mixed mortar is a matter of individual preference by the mason. In general, a mortar mixed to a "buttery" consistency will contain the proper amount of water. However, some masons prefer a stiffer mixture for setting stone than would be ordinarily used in setting brick or block. Stiff mortar may be helpful in setting particularly heavy stones.

Mortar is the preferred material for filling anchor holes. In certain circumstances, it may be desirable to utilize other materials for this purpose. Lead wool is one alternative; shim stock of noncorrosive material may be used provided it is not built up beyond a "snug" thickness. Increasingly, building joint sealants are being used for this purpose. They can be gunned into place directly from the tube. Non-shrink, high-strength or expansive grouts must not be used to fill anchor slots or holes.

When mortars are transported, the containers should be pre-wetted and covered to prevent evaporation. Stored sand should be covered to maintain proper moisture content and to prevent contamination by leaves, trash, etc.

Mortar systems may be used in conjunction with sealant

systems provided a joint tape is installed over the cured raked-back mortar. Systems of this kind share the ability of mortar to carry loads and the superior durability of sealants. However, they also share the inability of mortar systems to absorb much joint movement, especially when stone size reduces the ratio of joint area to total wall area. Leave at least one open joint every fifty feet in parapets and copings for later closing with backer rod and sealant. This will reduce damage due to linear expansion.

The 1/1/6 mix suggested here, or a prepared masonry mix, will provide good compressive strength (ability to support vertical loads), bond strength (ability to resist eccentric or lateral loads), and durability (weather resistance). In most Indiana Limestone applications, mortar no stronger than ASTM's N mix will be required. This can be job-mixed using the 1/1/6 mix suggested here. Richer mixes should not be used for pointing. ILI reproduces the following table for reference only.

**TABLE 1
Mortar Proportions by Volume**

| Mortar Type | Parts by Volume of Portland Cement | Parts by Volume of Hydrated Lime | Aggregate Ratio (Measured in Damp, Loose Conditions) |
|-------------|------------------------------------|----------------------------------|--|
| M | 1 | ¼ | Not less than 2¼ and not more than 3 times the sum of the volumes of cement and lime used. |
| S | 1 | over ¼ to ½ | |
| N | 1 | over ½ to 1¼ | |
| O | 1 | over 1¼ to 2½ | |

**TABLE 2
Property Specification Requirements**

| Mortar Type | Average Compressive Strength at 28 Days, Min. psi (MPa) | Water Retention, min % | Air Content, max % |
|-------------|---|------------------------|--------------------|
| M | 2500 (17.2) | 75 | 12 |
| S | 1800 (12.4) | 75 | 12 |
| N | 750 (5.2) | 75 | 14 |
| O | 350 (2.4) | 75 | 14 |

pointing mortar joints

Pointing cut stone after setting, rather than full bed setting and finishing in one operation, reduces a condition which tends to produce spalling and leakage. Shrinkage of the mortar bed will allow some settling since the mortar bed hardens from the face in. If set and pointed in one operation, the setting, combined with the hardened mortar at the face, can set up stresses on the edge of the stone. For this reason, it is best to set the stone and rake out the mortar to a depth of ½" to 1½" for pointing with mortar or sealant application at a later date.

Pointing seals shrinkage cracks in the setting mortar. The

concave tooled joint provides maximum protection against leakage. A grout-bag or mortar gun will help place pointing without smears. When tooling joints, leave mortar tags in place until they are set, then remove with brush or trowel edge. NEVER BAG OR WET-WIPE LIMESTONE MORTAR JOINTS.

cold weather setting

The bond strength of mortar is considerably reduced when mortar is frozen prior to hardening. The chemical reaction between water and cement (hydration) progresses very slowly below 40 degrees F. Protection is necessary if the outside air temperature is 40 degrees and falling.

Admixtures or anti-freezes should not be used to lower the freezing point of mortar. The effectiveness of most of these compounds is due to the calcium chloride they contain acting as accelerators.

Calcium chloride cannot be used on limestone. Salts cause efflorescence and may cause spalling or flaking through recrystallization (crystal growth).

Heating all materials must be considered. Sand contains some moisture that will form ice when stored in freezing temperatures and must be heated to thaw the ice. Sand must be heated slowly to prevent scorching. Mixing water should not be above 160 degrees F to prevent the danger of flash set with cement. The mortars should be between 40 and 120 degrees F when used.

Stone should be covered with tarpaulin, felt paper, or polyethylene, and heating units used to warm the stone. Caution must be used to prevent smoke under the covering from salamanders.

Never set stone on a snow or ice-covered bed. Bond cannot develop between the mortar bed and frozen supporting surfaces.

If stone is to be set during cold weather the cold weather masonry construction recommendation of the International Masonry Industry All-weather Council should be followed.

dry setting

Much contemporary stonework is set "dry" – without mortar. In general, installations containing large panels, or unitized (preassembled) stones, or stones individually supported by attachment to structure rather than by weight-transfer joints to other stones, are set dry. Joints are closed with sealants. (See sections below.) Non-corrosive shims are used to achieve level. Historically, shims have been made from lead or nylon, but aluminum, stainless steel, lead, or other plastics may be successfully used. Shim material is less important than quantity: setters must be certain that a sufficient area of shim surface is used to avoid concentrating loads.

COLD WEATHER MASONRY CONSTRUCTION AND PROTECTION RECOMMENDATIONS

by the INTERNATIONAL MASONRY INDUSTRY ALL-WEATHER COUNCIL

The consensus of this Council regarding recommendations for cold weather masonry construction and protection is as follows:

| WORK DAY TEMPERATURE | CONSTRUCTION REQUIREMENT | PROTECTION REQUIREMENT |
|------------------------|---|---|
| above 40° F | Normal masonry procedure | Cover walls with plastic or canvas at end of work day to prevent water entering masonry. |
| 40° F - 32° F | Heat mixing water to produce mortar temperatures between 40° F - 120° F. | Cover walls and materials to prevent wetting and freezing. Covers should be plastic or canvas. |
| 32° F - 25° F | Heat mixing water and sand to produce mortar temperatures between 40° F - 120° F. | With wind velocities over 15 mph provide wind-breaks during the work day and cover the walls and materials at the end of the work day to prevent wetting and freezing. Maintain masonry above freezing for 16 hours using auxiliary heat or insulated blankets. |
| 25° F - 20° F | Mortar on boards should be maintained above 40° F. | |
| 20° F - 0° F and below | Heat mixing water and sand to produce mortar temperatures between 40° F - 120° F. | Provide enclosures and supply sufficient heat to maintain masonry enclosure above 32° F for 24 hours. |

sealants & joint movement

Sealants and mortar are similar only in that they close joints. Mortar joints typically carry the weight of stones above; sealant joints cannot perform that function. However, mortar joints can be finished using a sealant bead in lieu of pointing provided a joint tape or other sealant stop is used. Sealants are always the preferred joint closer where stone abuts other materials such as aluminum, glass, plastic or other man-made material, or in long vertical joints such as at column covers or quirk miters.

A successful sealant job requires a backer rod, joint tape or other "caulk stop" which will flex with the sealant. In the typical sealant joint, a backer rod is required to establish the depth of the sealant bead. If the joint is deeper than it is wide, it is likely to fail prematurely. Failure to observe the depth-to-width ratio required by all sealants accounts for 90% of joint problems with these systems.

In some cases, it may be necessary to transfer weight from stone to stone in an otherwise non-loading system. Typically, mortar would be used for that purpose. If there is no other mortar usage on the project, it may be preferable to use a shim system to carry the weight. Shims should be of a noncorrosive material. A sufficient number of square inches of material must be used to avoid squeezing and loss of joint width, as well as to avoid

point-loading the stones. Typical materials used as shims are lead pads or plastic such as nylon, or aluminum sheet. The intent is to spread the load.

JOINT SEALANT DESIGN

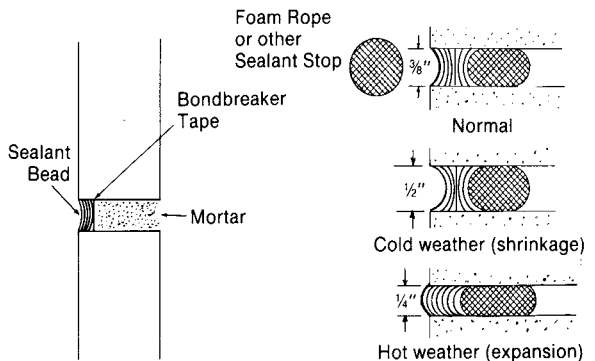

Note: Shims may be substituted in sufficient area to support the load.

which sealant is best for Indiana Limestone?

The fact is, there is no best sealant for limestone, or for any other material. The proper sealant is determined primarily by the void, or width of joint between materials, and by the expected opening and closing of that joint in thermal expansion/contraction.

Limestone's coefficient of thermal expansion is among the lowest of all building materials. But even that slight expansion must be accommodated. And when limestone is supported by, or set adjacent to, materials with greater expansion potential, those joints may require more than the usual attention. Mortar joints accommodate very little movement, but mortar is sufficient for moisture protection when used in firm, substantial walls with limestone weatherface and low-coefficient materials as back-up. When adjacent materials are moving, or when limestone is allowed to move by the materials to which it is affixed, joint sealants may be required to keep the wall watertight.

qualities vary among sealant types

1. **Urethanes/Polyurethanes:** Tack-free 2-24 hours. Excellent adhesion, with no primer required for most substrates though often suggested for best long-term adhesion on limestone. 15-20 year life. Good resistance to UV, ozone, and acid atmospheres. Can accommodate movement in the joint up to 50% of design width. Good color selection. -40 to +180 degrees F service temperature range.
2. **Acrylic polymeric:** Tack-free 1-2 hours after installation, excellent adhesion; 5-10 year life; good for dissimilar materials; -30 to +180 degrees F service temperature range; good resistance to UV, ozone and acid. 10-15% movement capability; primers not required; broad color and selection.
3. **Silicones:** Tack-free time 5-30 minutes; excellent adhesion; 20 year life; service temperature -60 to +300 degrees F; good for dissimilar materials; excellent resistance to attack agents; may require primers; 50% movement capability; broad color selection. May cause staining.
4. **Acrylic Latex:** Tack-free time 15-30 minutes. Fair adhesion. Fair resistance to UV and ozone. No primers, 12-15% joint movement capability; limited colors; sealant bead accepts paint. Shrinkage and exterior usage ability a consideration in some formulations. 2-10 year life. Tend to become brittle with age.
NOTE: Chosen sealant should be tested for compatibility, stain-resistance, etc.

always use a backer rod or tape

Sealant joints are usually empty of other materials; they require a backer rod or caulk-stop. The placement of the backer rod determines how deep (thick) the sealant bead will be; to a large extent, thickness determines how well the joint performs. In general, the beads in the joints which fail are TOO THICK; the backer rod is placed too deep in the joint, or is missing. Chemical compatibility between sealant and backer rod is important. Good information on sealant design is available from sealant manufacturers. ILI's Handbook provides some information as well.

mortar plus sealant makes a good joint, too

Mortar joints may be finished with a weatherface of sealant. The joint must be raked back, and fitted with a joint tape. Tape will serve the same purpose as the backer rod, i.e., allow the sealant to adhere to two parallel surfaces only. Much joint failure is the result of three-side adhesion, so make sure yours have a backer rod or tape as the first step.

In general, sealants in this high-performance category have good service lives. They are easily gunned, although toolability varies both between types and between brands of a single type.

stains

Sealants cause stain in some materials. Although this is not known to be a major problem in Indiana Limestone, the question is a good one to raise with the sealant supplier.

expansion joints

In general, expansion joints will relieve the pressure developing from differential expansion of skin and frame in masonry buildings. In a limestone building with a steel frame where ambient temperature may vary from 0 to 130 degrees, a rule-of-thumb dictates the placement of expansion joints every 50 feet minimum. The placement

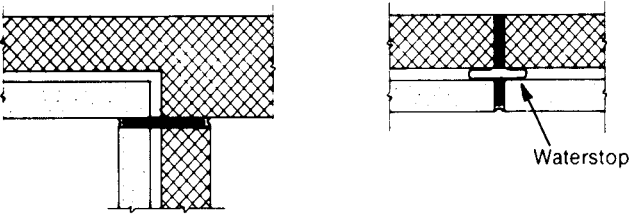

of these joints will ordinarily be determined by the project engineer.

Expansion joint planning should include areas at grade, where structural movement can have the same effect as thermal movement higher in the building.

For more complete information on expansion joints, see the current Indiana Limestone Handbook.

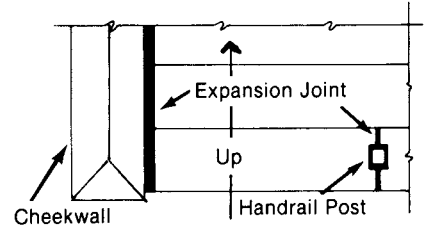

EXPANSION JOINT AT STAIR ENDS AND HANDRAIL POSTS

pressure-relieving joints

In support systems where large panels span floor to floor or column, or where smaller stones are installed using a combination of mortar and sealant joints, it is necessary to provide for stone expansion between support clips or continuous angles. The simplest way to accomplish this is to leave empty space UNDER the angles or clips.

This space, ordinarily $\frac{1}{4}$ " or more allows the lower stone panel or assembly the space it needs to accommodate thermal and structure movement. Alternately, the space may be filled with a compressible material which will perform the same function. Failure to allow for movement can result in the cracking and spalling of stone, loss of joint space, deformed angle or clip support, and potential loss of structural integrity.

Where a lateral restraint anchor crosses such a joint (see "Handling Cautions") flexibility must be built into the anchor system as well. A simple and effective method is to place a compressible material in the bottom of dowel holes, disc anchor slots and other metal anchor chase or slot. This is particularly important where a single anchor restrains two stones.

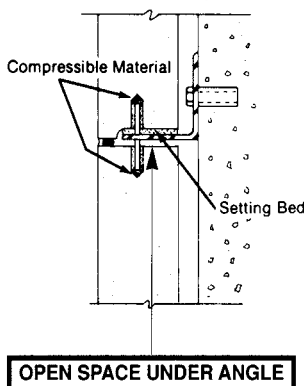

Pressure-relieving joints must be closed with sealants. Never use mortar or pointing in these joints.

dampproofing and stain avoidance

Where limestone is to be used at or below grade, dampproofing must be applied. Where there is a possibility that stone backs or beds will be wetted periodically (as in situations where waterstops exist within cavity walls) dampproofing may be desirable.

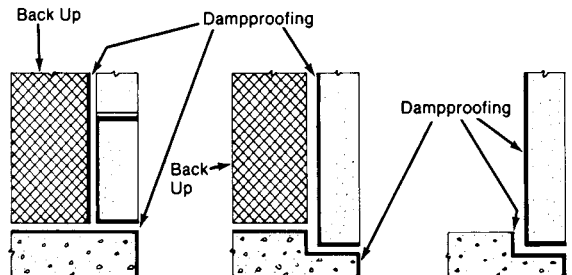

Although dampproofing the face of backup or structural concrete is helpful, it is not a substitute for backpainting the stone with a suitable material in these conditions.

In cases where limestone is to be covered by soil or paving at grade, and where the stones will present an evaporation surface above grade, the dampproofing must be carried up the partially exposed face at least to grade level.

Acceptable materials are any of the bituminous preparations made for the purpose, including asphaltic emulsion paint and spray-grade mastic materials and the cemen-

The conditions shown here illustrate the procedure for isolating Indiana Limestone from the possible harmful effects of ground and construction moisture. Weep holes, moisture barriers and thoughtful design will avoid most potential problem areas. The dark lines shown throughout these illustrations represent either waterproof cementitious stonebacking or asphaltic emulsion paint. See comments on the relative merits of each material and suggestions for their use in DAMPPROOFING.

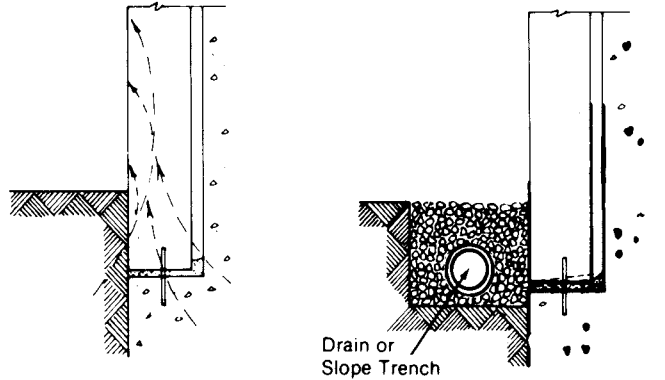

Where stone is exposed below grade it MUST be protected.

--- Path of Moisture through Stone
 ——— Heavy lines indicate dampproofing

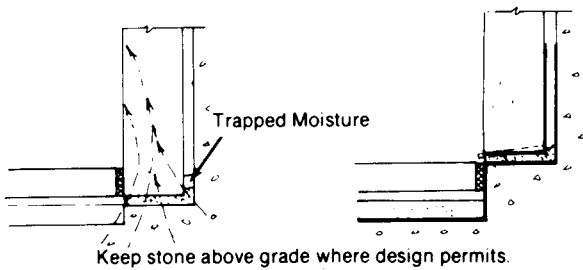
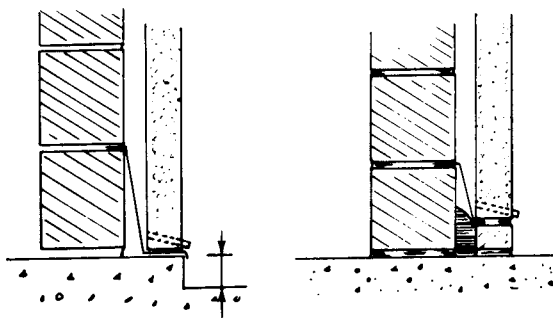

Note: Isolate stone from grade moisture with a concrete ledge or a dampproofed starter course with flashing as shown.

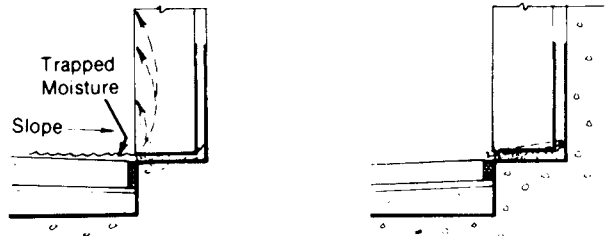

Note: Indiana Limestone paving must be properly sloped for good surface drainage; avoid low spots where surface moisture can collect. See p. 52.

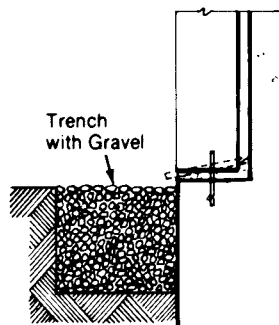

A gravel-filled trench will help prevent soil splash.

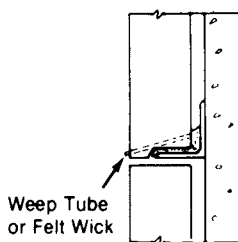

Weep continuous and other angle supports where moisture collects.

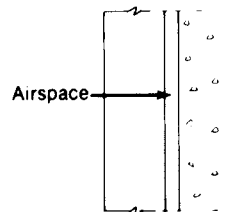

Air spaces isolate stone backs from moisture.

tious job-mixed powder materials. In general, the same materials typically used below grade on structure are acceptable.

The intent of the treatments is to isolate the stone from surface and ground water containing alkali, chlorides and other stain-producing or crystal-forming materials. It is desirable to protect stone from surface water by attention to proper slope of grade to induce good drainage. But proper dampproofing, well-applied, is essential where limestone can absorb moisture from grade or from within the walls.

The term "parging," sometimes seen in specifications, requires the application of a coat of white mortar to the backs of stones. Although the intent of parging is the same as that of dampproofing, ILI believes that the materials and procedures described here, if done correctly, will produce superior results.

water repellent treatments (sometimes miscalled sealers, or waterproofers)

Some masonry technical groups disapprove the use of water repellents. ILI takes a neutral position on the question although we recognize that these treatments afford a degree of cosmetic protection to masonry walls. Their use will provide repellency (not waterproofing) for a number of years, and will help keep walls dryer and cleaner looking for that period of time. A guarantee or other statement of performance should be available from manufacturers of water repellent materials.

Many architects and their clients expect longer life and better performance than water repellents are capable of providing. Silicones, silicates, stearates, silanes, acrylics, and the various other active ingredients in these preparations will lose effectiveness over time. In addition they will not bridge cracks in mortar joints. They will not render the wall "waterproof." They should not be used below grade.

If a water repellent is to be used on Indiana Limestone, follow the manufacturer's instructions. Arrange to have his representative at the site when the treatment is to begin, and get the assurance of both applicator and manufacturer that the substrate is in the right condition, that weather is right, that the tool proposed for use is acceptable, and that flow rate and coverage are agreed on. Get a statement of service life for the materials, and find out who to contact if things go wrong.

In general, Indiana Limestone to be treated with a water repellent should be clean, free of dust, and completely dry. Do not apply repellents over stain or discoloration.

Make sure the applicator has protected surrounding shrubbery, adjacent materials not to be treated, and walkway and traffic areas nearby or within range of any wind-driven spray. The applicator should be able to provide evidence of insurance for any damage claims.

Water repellents tend to be highly labor-sensitive; successful applications depend on good workmanship. Some formulations may be incompatible with joint sealants, plastics or finishes. ILI does not recommend specific products. However, we will comment further to interested inquirers.

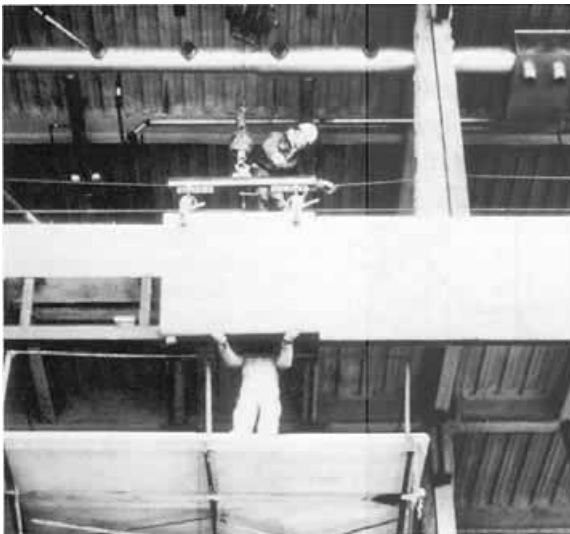

A spreader bar may allow better adjustment when using a two-clamp rig.



nominal height of masonry walls by courses for brick & block

| COURSES | REGULAR 4 2¼" bricks + 4 equal joints = | | | | | MODULAR 3 bricks + 3 joints = | CONCRETE BLOCKS | |
|---------|--|-----------|-----------|-----------|-----------|-------------------------------------|-------------------------|-------------------------|
| | 10" | 10½" | 11" | 11½" | 12" | 8" | 3⅝" blocks ¾" joints | 7⅝" blocks ¾" joints |
| | ¼" joints | ⅜" joints | ½" joints | ⅝" joints | ¾" joints | | | |
| 1 | 2½" | 2⅝" | 2¾" | 2⅞" | 3" | 2⅞" | 4" | 8" |
| 2 | 5" | 5¼" | 5½" | 5¾" | 6" | 5⅞" | 8" | 1' 4" |
| 3 | 7½" | 7⅞" | 8¼" | 8⅞" | 9" | 8" | 1' 0" | 2' 0" |
| 4 | 10" | 10½" | 11" | 11½" | 1' 0" | 10⅞" | 1' 4" | 2' 8" |
| 5 | 1' 0½" | 1' 1⅞" | 1' 1¾" | 1' 2⅞" | 1' 3" | 1' 1⅞" | 1' 8" | 3' 4" |
| 6 | 1' 3" | 1' 3¾" | 1' 4½" | 1' 5¼" | 1' 6" | 1' 4" | 2' 0" | 4' 0" |
| 7 | 1' 5½" | 1' 6⅜" | 1' 7¼" | 1' 8⅞" | 1' 9" | 1' 6⅞" | 2' 4" | 4' 8" |
| 8 | 1' 8" | 1' 9" | 1' 10" | 1' 11" | 2' 0" | 1' 9⅞" | 2' 8" | 5' 4" |
| 9 | 1' 10½" | 1' 11⅞" | 2' 0¾" | 2' 1⅞" | 2' 3" | 2' 0" | 3' 0" | 6' 0" |
| 10 | 2' 1" | 2' 2¼" | 2' 3½" | 2' 4¾" | 2' 6" | 2' 2⅞" | 3' 4" | 6' 8" |
| 11 | 2' 3½" | 2' 4⅞" | 2' 6¼" | 2' 7⅝" | 2' 9" | 2' 5⅞" | 3' 8" | 7' 4" |
| 12 | 2' 6" | 2' 7½" | 2' 9" | 2' 10½" | 3' 0" | 2' 8" | 4' 0" | 8' 0" |
| 13 | 2' 8½" | 2' 10⅞" | 2' 11¾" | 3' 1⅞" | 3' 3" | 2' 10⅞" | 4' 4" | 8' 8" |
| 14 | 2' 11" | 3' 0¾" | 3' 2½" | 3' 4¼" | 3' 6" | 3' 1⅞" | 4' 8" | 9' 4" |
| 15 | 3' 1½" | 3' 3⅞" | 3' 5¼" | 3' 7⅞" | 3' 9" | 3' 4" | 5' 0" | 10' 0" |
| 16 | 3' 4" | 3' 6" | 3' 8" | 3' 10" | 4' 0" | 3' 6⅞" | 5' 4" | 10' 8" |
| 17 | 3' 6½" | 3' 8⅞" | 3' 10¾" | 4' 0⅞" | 4' 3" | 3' 9⅞" | 5' 8" | 11' 4" |
| 18 | 3' 9" | 3' 11¼" | 4' 1½" | 4' 3¾" | 4' 6" | 4' 0" | 6' 0" | 12' 0" |
| 19 | 3' 11½" | 4' 1⅞" | 4' 4¼" | 4' 6⅞" | 4' 9" | 4' 2⅞" | 6' 4" | 12' 8" |
| 20 | 4' 2" | 4' 4½" | 4' 7" | 4' 9½" | 5' 0" | 4' 5⅞" | 6' 8" | 13' 4" |
| 21 | 4' 4½" | 4' 7⅞" | 4' 9¾" | 5' 0⅞" | 5' 3" | 4' 8" | 7' 0" | 14' 0" |
| 22 | 4' 7" | 4' 9¾" | 5' 0½" | 5' 3¼" | 5' 6" | 4' 10⅞" | 7' 4" | 14' 8" |
| 23 | 4' 9½" | 5' 0⅞" | 5' 3¼" | 5' 6⅞" | 5' 9" | 5' 1⅞" | 7' 8" | 15' 4" |
| 24 | 5' 0" | 5' 3" | 5' 6" | 5' 9" | 6' 0" | 5' 4" | 8' 0" | 16' 0" |
| 25 | 5' 2½" | 5' 5⅞" | 5' 8¼" | 5' 11⅞" | 6' 3" | 5' 6⅞" | 8' 4" | 16' 8" |
| 26 | 5' 5" | 5' 8¼" | 5' 11½" | 6' 2¾" | 6' 6" | 5' 9⅞" | 8' 8" | 17' 4" |
| 27 | 5' 7½" | 5' 10⅞" | 6' 2¼" | 6' 5⅞" | 6' 9" | 6' 0" | 9' 0" | 18' 0" |
| 28 | 5' 10" | 6' 1½" | 6' 5" | 6' 8½" | 7' 0" | 6' 2⅞" | 9' 4" | 18' 8" |
| 29 | 6' 0½" | 6' 4⅞" | 6' 7¾" | 6' 11⅞" | 7' 3" | 6' 5⅞" | 9' 8" | 19' 4" |
| 30 | 6' 3" | 6' 6¾" | 6' 10½" | 7' 2¼" | 7' 6" | 6' 8" | 10' 0" | 20' 0" |
| 31 | 6' 5½" | 6' 9⅞" | 7' 1¼" | 7' 5⅞" | 7' 9" | 6' 10⅞" | 10' 4" | 20' 8" |
| 32 | 6' 8" | 7' 0" | 7' 4" | 7' 8" | 8' 0" | 7' 1⅞" | 10' 8" | 21' 4" |
| 33 | 6' 10½" | 7' 2⅞" | 7' 6¾" | 7' 10⅞" | 8' 3" | 7' 4" | 11' 0" | 22' 0" |
| 34 | 7' 1" | 7' 5¼" | 7' 9½" | 8' 1¾" | 8' 6" | 7' 6⅞" | 11' 4" | 22' 8" |
| 35 | 7' 3½" | 7' 7⅞" | 8' 0¼" | 8' 4⅞" | 8' 9" | 7' 9⅞" | 11' 8" | 23' 4" |
| 36 | 7' 6" | 7' 10½" | 8' 3" | 8' 7½" | 9' 0" | 8' 0" | 12' 0" | 24' 0" |
| 37 | 7' 8½" | 8' 1⅞" | 8' 5¾" | 8' 10⅞" | 9' 3" | 8' 2⅞" | 12' 4" | 24' 8" |
| 38 | 7' 11" | 8' 3¼" | 8' 8½" | 9' 1¼" | 9' 6" | 8' 5⅞" | 12' 8" | 25' 4" |
| 39 | 8' 1½" | 8' 6⅞" | 8' 11¼" | 9' 4⅞" | 9' 9" | 8' 8" | 13' 0" | 26' 0" |
| 40 | 8' 4" | 8' 9" | 9' 2" | 9' 7" | 10' 0" | 8' 10⅞" | 13' 4" | 26' 8" |
| 41 | 8' 6½" | 8' 11⅞" | 9' 4¾" | 9' 9⅞" | 10' 3" | 9' 1⅞" | 13' 8" | 27' 4" |
| 42 | 8' 9" | 9' 2¼" | 9' 7½" | 10' 0¾" | 10' 6" | 9' 4" | 14' 0" | 28' 0" |
| 43 | 8' 11½" | 9' 4⅞" | 9' 10¼" | 10' 3⅞" | 10' 9" | 9' 6⅞" | 14' 4" | 28' 8" |
| 44 | 9' 2" | 9' 7½" | 10' 1" | 10' 6½" | 11' 0" | 9' 9⅞" | 14' 8" | 29' 4" |
| 45 | 9' 4½" | 9' 10⅞" | 10' 3¾" | 10' 9⅞" | 11' 3" | 10' 0" | 15' 0" | 30' 0" |
| 46 | 9' 7" | 10' 0¾" | 10' 6½" | 11' 0¼" | 11' 6" | 10' 2⅞" | 15' 4" | 30' 8" |
| 47 | 9' 9½" | 10' 3⅞" | 10' 9¼" | 11' 3⅞" | 11' 9" | 10' 5⅞" | 15' 8" | 31' 4" |
| 48 | 10' 0" | 10' 6" | 11' 0" | 11' 6" | 12' 0" | 10' 8" | 16' 0" | 32' 0" |
| 49 | 10' 2½" | 10' 8⅞" | 11' 2¾" | 11' 8⅞" | 12' 3" | 10' 10⅞" | 16' 4" | 32' 8" |
| 50 | 10' 5" | 10' 11¼" | 11' 5½" | 11' 11¼" | 12' 6" | 11' 1⅞" | 16' 8" | 33' 4" |

fabrication tolerances for cut indiana limestone

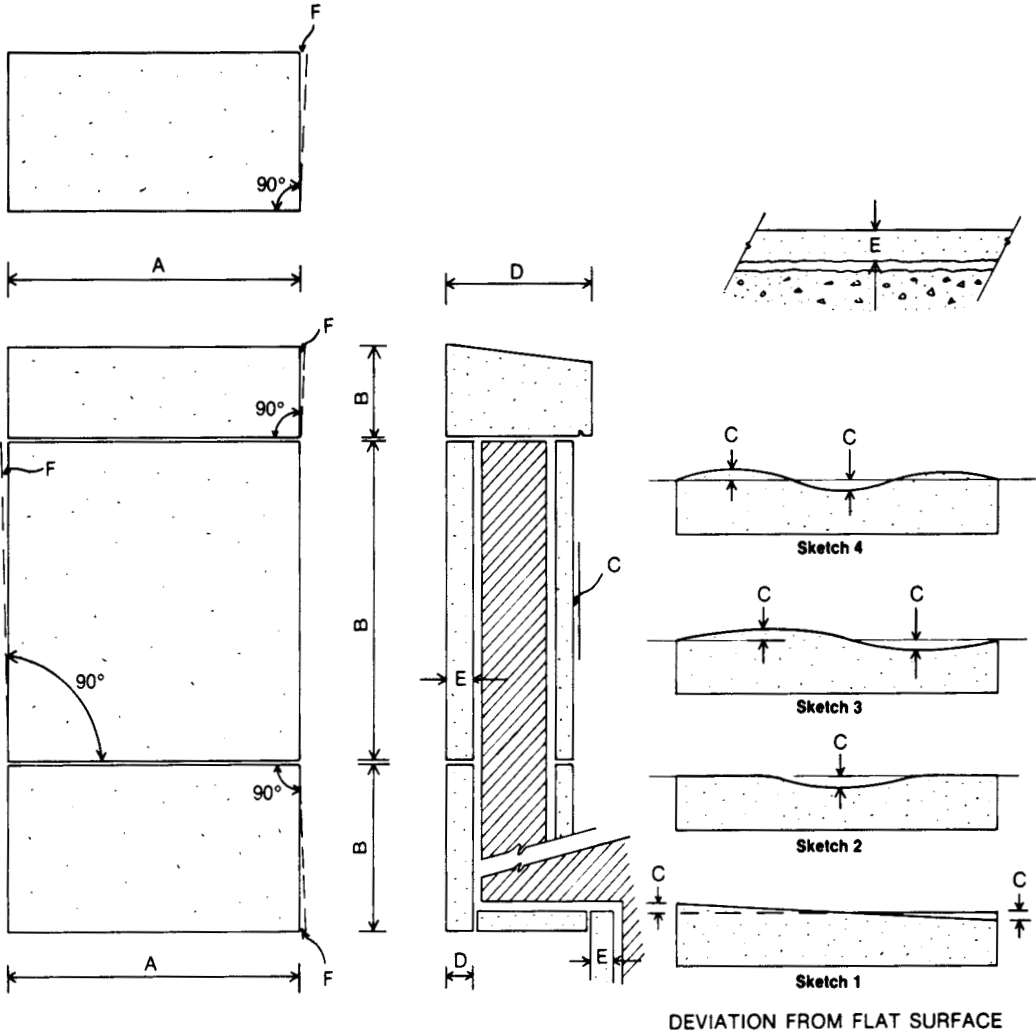

| | A | B | C | D | E | F |
|------------------------|--------------|--------------|--|----------------|--------------------|-----------------------|
| | Length | Height | Deviation From Flat Surface Exposed Face | Critical Depth | Non-Critical Depth | Deviation From Square |
| Smooth Machine Finish | $\pm 1/16''$ | $\pm 1/16''$ | $-1/16''$ to $+1/16''$ | $\pm 1/16''$ | $\pm 1/2''$ | $\pm 1/16''$ |
| Diamond Gang Finish | $\pm 1/16''$ | $\pm 1/16''$ | $-1/4''$ to $+1/4''$ | $\pm 1/8''$ | $\pm 1/2''$ | $\pm 1/16''$ |
| Chat Sawed Finish | $\pm 1/16''$ | $\pm 1/16''$ | $-1/4''$ to $+1/4''$ | $\pm 1/8''$ | $\pm 1/2''$ | $\pm 1/16''$ |
| Shot Sawed Finish | $\pm 1/16''$ | $\pm 1/16''$ | $-1/2''$ to $+1/2''$ | $\pm 1/4''$ | $\pm 1/2''$ | $\pm 1/16''$ |
| * Pre-Assembled Units | $\pm 1/8''$ | $\pm 1/8''$ | $-1/8''$ to $+1/8''$ | $\pm 1/8''$ | $\pm 1/2''$ | $\pm 1/8''$ |
| Panels over 50 sq. ft. | $\pm 1/8''$ | $\pm 1/8''$ | $-1/8''$ to $+1/8''$ | $\pm 1/8''$ | $\pm 1/2''$ | $\pm 1/8''$ |

Custom Finishes—Consult fabricator for texture variations, nominal thickness and jointing.

*As multiple-stone units assembled by limestone suppliers increase in size beyond a nominal 50 SF total area, and as steel or other framing members used in assembly become more complex than required to accomplish a single plane change, tolerances A through F shown above may be affected. Where such increased tolerances might intrude on esthetic or installation factors, it will be the responsibility of the architect and erector to determine acceptable tolerances in cooperation with the limestone supplier.

fabrication tolerances/definitions

| | |
|---|--|
| Length (A) | The overall horizontal dimension of an individual unit or stone as it is incorporated into the construction. |
| Height (B) | The overall vertical dimension of an individual unit or stone as it is incorporated into the construction. |
| Deviation from Flat Surface Exposed Face (C) | <p>A flat surface, by definition, is a surface in which, if any two points are taken, the straight line that joins them lies wholly in that surface. This definition, when applied to the fabrication of Diamond Gang Sawed, Chat Sawed and Shot Sawed finishes, limits the acceptable amount of "run out" or deviation of the gang saw blade used in the fabrication process.</p> <p>The first basic fabrication process of Cut Indiana Limestone requires the sawing of large quarry slabs of stone of the required thickness. This is accomplished in a gang saw which resembles a large "hack saw" utilizing long thin blades (in excess of 17'-0" long). A perfectly straight and true cut from the top to the bottom of the quarry block would result in zero deviation from a flat surface. Due to limitations of blade tension, stiffness, and other operating factors, it is not possible to saw perfectly straight and true. The blade may saw slightly to either side of the perfect flat surface.</p> <p>Diamond Gang Sawed, Chat Sawed, and Shot Sawed surface finishes are obtained in the gang saw process described above. No further machining can be done to flatten the surfaces because the surface finish would be destroyed. The tolerance "Deviation from Flat Surface" therefore becomes a gang sawing tolerance, or blade "run out" tolerance. Four examples of the application of this tolerance are shown in Sketch 1 thru Sketch 4.</p> <p>The "Smooth Finish" is obtained by planing or grinding the sawed slabs previously described. Thus, the deviation permissible is much less, as shown in the fabrication tolerance standards.</p> |
| Critical Depth (D) | The required dimension of the stone from the finished face to the finished or semi-finished back of the stone as it is incorporated into the construction. |
| Non-Critical Depth (E) | The required dimension of the stone from the finished face to the unfinished back of the stone as it is incorporated into the construction. |
| Deviation From Square (F) | The maximum deviation from square using the longest edge as the base. |
| Preassembled Units | Stone assemblies consisting of two or more stones, plant assembled, using high strength adhesives and metal accessories where required. |
| Smooth Finish | This is the generally recognized smoothest of the standard limestone finishes. It presents the least interruption of surface to eye or touch, and may be produced by a variety of machines. |
| Diamond Gang Sawed Finish | This finish is comparatively smooth but may contain some parallel markings and scratches. Direction of the markings and scratches will be vertical or horizontal in the wall unless the direction is specified. |
| Chat-Sawed Finish (Gang Sawed) | A medium rough somewhat uniform granular finish. It is produced by sawing with a coarse abrasive containing some metallic minerals which may add permanent brown tones to the natural color variations. This finish may contain parallel score or saw marks. Direction of the score or saw marks will be vertical or horizontal in the wall unless the direction is specified. |
| Shot Sawed Finish (Gang Sawed) | A coarse, uneven finish ranging from a pebbled surface to one ripped with irregular parallel grooves. Direction of the grooves will be vertical or horizontal in the wall unless the direction is specified. The random markings are obtained by using steel shot in the sawing process. The shot markings are uncontrolled and deviations in the sawn face may appear at the joint lines. Additional color tones may appear due to varying amounts of rust stains from the steel shot. |
| Custom Finishes | A wide variety of these finishes is available. Custom designed, textural finishes are a regular product of cooperation between architect and fabricator. Special tolerances, when required, should be established by agreement. |

cleaning Indiana Limestone in new construction

Limestone received at the job site may have saw slush, planer dust, and road dirt on its surfaces. Some contractors prefer to wash stones as they unload the trucks and shake out the loads. Where this is impractical, the final washing down after installation will remove those materials. However, it may be necessary to clean joint surfaces ahead of a general cleandown to assure good adhesion of mortar or sealant.

There is no single “best” way to clean Indiana Limestone in new construction. One simple and effective method is high-pressure water. City-pressure water and fiber brushes are also an effective combination. Ordinarily, no chemical additives will be needed, with the occasional exception of a detergent or mild soap to remove stubborn road grime or jobsite dirt. Care must be exercised with fresh joint materials.

Whatever system is used, the final effect should be clean, grit-free stone.

interior stone

Interior stone should be stored on edge with the individual stone faces exposed to weather. Do not set interior stone when dirty or stained. Because it can be difficult to clean interior stone when other finishes are in place, washing as noted above should be done prior to installation.

use care cleaning brick above limestone

No acids or chemicals should be used in cleaning new Indiana Limestone. Where brick above limestone is to be cleaned with acid or commercial mortar blaster, limestone must be protected. At a minimum, soak the stone thoroughly and keep it wet while cleaning proceeds above. Ideally, the stone will be draped with polyethelene sheeting with taped joints. Keep stone wetted under the drapes until cleaning is completed.

mortar smears

Mortar smears on limestone can be difficult to remove. Mortar or pointing can be kept off the difficult vertical joint areas by placing it with a grout-bag. Don't attempt to remove mortar tags until mortar has taken its initial set. If you do get smears, try gentle scrubbing with white vinegar and fiber brushes. Dip wet brushes in limestone grit for tough smears. ILI will respond to specific questions on this and related subjects.

stains on new work

Occasionally brown (alkali) stain appears on new con-

struction. Other than mortar smears, this condition is the most troublesome for contractors. Given time, the stain will disappear; repeated washing with clear water and trisodium phosphate or other detergent, scrubbed on with fiber brushes will reduce its intensity. Moisture from washings must be kept from contacting stone beds or backs. (See section on dampproofing.)

Brown stain may occur where high-alkaline moisture can reach the backs and beds of limestone. Such conditions as open, unglazed windows which admit rain to concrete block backup or concrete floors; or when wash from concrete pours leaks down into wall cavities or otherwise gets behind installed limestone; or in cases where limestone is used as the front of a form for pouring concrete; or where sidewalks are poured against installed limestone. Brown stain can be especially troublesome on paving, curbing, steps and platforms when these elements are not dampproofed. Stone in these forms tends to be constantly wetted from ground moisture, which in turn wets concrete pads and mortar beds. These materials contain relatively large amounts of alkali.

There is ordinarily not sufficient water in mortar to produce an intense stain. The typical ratio of mortar bed to stone area is too low to contribute heavily to this type of stain. Where mortar is the culprit, the stain is usually quite light in color, and limited to stone areas adjacent to the joints. Walls which are slushed or grouted are candidates for alkali stain; grout is typically of pourable quality, meaning it will contain much more moisture than ordinary pointing or setting mortar.

To eliminate the possibility of stain, it is necessary to stop the entrance of the water which carries the alkali. If moisture cannot reach the backs, beds, and joint surfaces of the stones, or if it can be prevented from coming through the stone, this condition cannot develop. Dampproofing the backs of stones is the simplest way to avoid problems. It is cheap insurance.

Stain removal requires large amounts of water (see below). For this reason, stain on interior stone can be difficult to remove. Proper installation order and stone placement can help avoid stains. Dampproofing should be used if necessary.

removing stains

BROWN (ALKALI) STAIN — No treatment has proved successful for the removal of the brown stain due to staining cements when the wall is wet. For this reason, before any treatment is undertaken for its removal, all leaks on the wall must be stopped. As the wall dries out natural weathering agencies will usually remove the stain in time, leaving no trace behind.

If necessary to remove stain artificially, wash affected ar-

eas with tri-sodium phosphate or other detergent, agitate with scrub brushes, and rinse with water. When using high pressure, stay below 1200 psi. Use a fan-shaped nozzle no closer than 6" to the face of the stone. Steam cleaners are also effective. Either system may require more than one pass.

GREEN STAIN FROM COPPER AND BRONZE— Scrub the stone with a diluted solution of potassium-cyanide containing from one to two ounces of the cyanide per quart of water, or in lieu of this use a sodium-cyanide solution of the same strength. Follow this treatment with a thorough drenching of the surface with clear water. This will usually completely remove such staining and leave no apparent damage to the surface of the stone. *These compounds are poison, and must be carefully handled.*

OIL STAINS — If the stains are fresh they can sometimes be drawn out with a lime poultice. However, if a more drastic treatment is necessary, saturate a blotter with either amyl acetate or benzene and place over the stain making sure the blotter extends well over the boundaries of the stain. Place a hot iron over the blotter. This hastens evaporation of the solvent and consequently hastens the removal of the stain. In severe cases the treatment may need to be repeated. Remaining "ghosting" can be removed by washing with tri-sodium phosphate, or other detergent.

TAR STAINS — Slice off all the tar possible with razor blade being careful not to smear the adjoining surface of the stone. After this has been done follow directions for removing oil stains. Tar may be chilled with ice to aid in cutting it away.

BLOOD STAINS — Wet the stain with water, then dust over with a layer of sodium peroxide. Sprinkle with water and allow the peroxide to remain a few minutes, then scrub vigorously with copious amounts of clear water. After the sodium peroxide has been washed off, scrub with a ten percent solution of formic acid.

RUST STAINS — The best treatment for removal of rust stains is to scrub with a hot concentrated solution of oxalic acid. Follow this treatment by a thorough drenching with clear water.

Additional information on this subject is contained in ILI's booklet, Design & Procedure Aids, copies of which are available to architects and specifiers on request.

finishes, colors and grades of Indiana Limestone

NOTE: Specifications for Indiana Limestone should call out a finish, a color and a grade. Samples should be labeled to indicate compliance, and should show the speci-

fied characteristics either as a range in a group of samples, or as representative of a supply source in a single sample.

Standard surface textures of Indiana Limestone include Smooth, Tooled, Shot- or Chat-sawed, Rock- or Split-face, and a number of custom or specialty finishes generally called "broached." These finishes tend to have names or numbers assigned by the fabricating company which developed them.

Grades of Indiana Limestone are Select, Standard and Rustic. The grades relate to the grain size and other natural characteristics of the material, with the finer grades having smaller and more uniform grain particles.

The color of Indiana Limestone is either Buff or Gray, or the combination of the two, named Variegated. ILI allows variation in color tone in the two primary colors, although the range is quite narrow for a natural material. The dividing line between buff and gray in Variegated may be at any angle. It may be easily visible or indistinct. Depending on the intensity of the two colors, Variegated stone may appear nearly monochromatic, or it may seem almost to be machine-assembled.

GRADE AND COLOR CLASSIFICATIONS

| | | | |
|-------|--|------------|----------|
| | | COLOR | |
| | | BUFF | GRAY |
| GRADE | | SELECT | SELECT |
| | | STANDARD | STANDARD |
| | | RUSTIC | RUSTIC |
| | | VARIEGATED | |

finishes—description and adaptability

Indiana Limestone is available in a wide variety of standard machine finishes. The selection of the surface finish should be considered in conjunction with the selection of the grade of stone. The smooth finishes enhance the quality of the finer textured grades of stone and are the most commonly used. The rougher finishes are often specified for used on the coarser stones.

SMOOTH FINISH

This is the least textural of standard limestone finishes, presenting a minimum of surface interruption to eye or touch. Smooth Finish may be produced by a variety of

machines including planers, grinders and circular sanders. Smooth Finish may be applied to all surfaces, flat or molded.

COARSE & TEXTURED FINISHES

A. PLUCKED: A machine finish obtained by rough planing the surface of the stone, thus breaking or plucking out small particles. This gives an interesting rough texture. Plucked may be used as a finish on the stone trim of buildings faced with a smooth finish.

B. MACHINE TOOLED: This finish consists of cutting parallel, concave grooves in the stone. It is available in four, six or eight bats (grooves) to the inch. The depth of the groove varies with the number of bats used but will range from $\frac{1}{32}$ " $\frac{1}{16}$ " deep. Machine tooling is used primarily on ashlar surfaces. Tooled trim work can be economically machine cut only along the long dimension of the stone, although it can be done on any stone in any direction.

C. CHAT SAWED: This finish results from the use of a coarse abrasive during the gang sawing operation.

It has a coarse pebbled surface which closely resembles the appearance of sand blasting. It will sometimes contain shallow saw marks or parallel scores. Direction of the score or saw marks will be vertical and/or horizontal in the wall unless the direction is specified. This finish may have a slight variation in color due to the presence of iron oxide in the saw slurry resulting from the wearing of the steel saw blades. This finish can be applied only to flat surfaces and is particularly suited to the various types of ashlar. For best economy, its use should be confined to the coarser grades of stone.

D. SHOT SAWED: This is a coarse, uneven finish ranging from a pebbled surface to one ripped with irregular, roughly parallel grooves. The random markings are obtained by using steel shot in the gang sawing process in combination with chat sand. The steel shot rusts during this process, permitting varying amounts of rust stain to develop—adding permanent brown tones to the natural color variations. It is not possible to obtain uniform distribution of the shot grooves over the entire surface of the stone. Some portions will have only a chat sawed finish. A shot sawed finish can be applied to flat surfaces only and should be confined to the coarser grades. Direction of the

grooves will be vertical and/or horizontal in the stone unless the direction is specified.

E. SPLIT FACE: A rough, uneven, concave-convex finish produced by the splitting action of a guillotine knife. The stones are split to the specified wall thickness (usually 3" to 4" thick), in random lengths, 1'-0" to 4'-0" long, and sawed to the specified course heights (see "The Finishing Touch," available from ILI). This finish is limited to stone sizes 4'-0" long by 1'-2" high.

seasoned stone

Like all natural stones, Indiana Limestone is wet when quarried. This moisture, or quarry sap, contains varying amounts of organic and chemical matter. Gray stone tends to contain more such moisture than Buff. As this material dries and stabilizes, the stone is said to "season." The time required for completion of the seasoning process varies with the amount of moisture in the ground; less time is required for stone in slab form than in block form. Some contracts require the prepurchase of stone in either blocks or slabs to eliminate quarry sap as a job site problem.

Due to demand and quarry stocks, it is sometimes necessary to fabricate and ship unseasoned stone. When erected, such stone may display a variation in color tone for a period of several months, sometimes as long as one year.

No specific action or cleaning procedure will notably improve the stone's appearance during this period, nor reduce the seasoning time. Left alone to weather, the stone invariably attains its characteristic light-neutral, even color.

No water repellents or other sealants should be applied during this period.

physical characteristics

All Indiana Limestone complies with the requirements of ASTM C-568, Type II.

The following table shows the most commonly specified strength requirements and physical characteristics for ordinary limestone uses.

table 1 performance tables

In most cases, the design of Indiana Limestone for building requires the consideration of these three properties only. ILI will report on other properties on request. A Technote on safety factors governing Indiana Limestone design is available on request from ILI or member companies.

| PROPERTY | VALUE | TEST PROCEDURE |
|---|---------------------------------------|----------------|
| Ultimate compressive strength dry specimens | 4,000 psi minimum (see note a) | ASTM C170 |
| Modulus of rupture dry specimens | 700 psi minimum (see note a) | ASTM C99 |
| Absorption | 7½% maximum (see note b) | ASTM C97 |

Note a: Most Indiana Limestone production possesses values higher than these minimums, which are listed for engineering reference. Special hard stones are produced by several quarry sources.

Note b: Indiana Limestone is available with lower values. Consult ILI for particulars.

Technotes

Safety Factors

The following safety factors are intended as a general guideline for determining maximum design loads and stresses in Indiana Limestone. These values represent the minimum safety factors which the Institute considers to be good practice for most applications. The designer must always use judgment based on the specific application to determine proper safety factors. Proper safety factors may be more conservative than the values suggested here, depending on the specific condition under consideration.

The physical properties of Indiana Limestone should be determined by lab test for the specific stone to be furnished. In lieu of lab tests, the minimum properties as listed in the *Indiana Limestone Handbook*, "Performance Tables," may be used to determine maximum allowable working stresses.

Safety Factors

STONE STRESSES

1. Stress Modes—Bending

1.1 Gravity Loads

Stone stressed in bending due to gravity loads: Use not less than 8 to 1 safety factor applied to the modulus of rupture to determine maximum allowable extreme fiber stresses.

1.2 Lateral Loads

Stone stressed in bending due to lateral loads (wind loads or seismic loads): Use not less than 8 to 1 safety factor applied to the modulus of rupture to determine maximum allowable extreme fiber stresses. A stress increase of 1/3 is permissible when the building code for the project permits this increase for other building materials. This provides a safety factor of not less than 6 to 1 for lateral load bending stresses.

1.3 Combined Gravity and Lateral Loads

Combined stone bending stresses due to gravity loads and lateral loads: Use not less than 8 to 1 safety factor applied to the modulus of rupture to determine maximum allowable extreme fiber stresses.

2. Stress Modes

- shear
- compression
- pure tension (axial loads)

Use not less than 8 to 1 safety factor applied to the ultimate test value (at failure) to determine maximum allowable working stresses.

3. Stone Stresses at Connection Points (Anchors)

Maximum allowable design loads for connection devices into the stone shall not exceed 25% of the failure load of the device as determined by actual tests in Indiana Limestone.

Anchoring devices subjected to both tension and shear shall be designed in accordance with the following interaction formula:

$$\frac{t}{T} + \frac{s}{S} \leq 1$$

- t = applied tension load
- T = allowable tension load
- s = applied shear load
- S = allowable shear load

The minimum depth of anchor embedment, the minimum center to center distance and the minimum edge distance shall be in accordance with the manufacturers' recommendations (expansion bolts and similar anchors).

It is good practice to install expansion bolts to an embedment depth greater than the recommended minimum depth. This re-

sults in substantial increases in the factor of safety with a negligible cost effect.

4. Stone Stresses at Post Tension Anchor Plates

These safety factors apply to stone stresses at post tension anchor plates which have been epoxied to the stone bearing surface to assure complete uniform pressure distribution. Tendon loads shall be precisely applied with specialized equipment by personnel experienced in the proper tensioning procedures.

Stone Compression Stress:

Stone Shear Stress:

Use not less than 6 to 1 safety factor applied to the ultimate test values (at failure) to determine maximum allowable working stresses.

Safety Factors

STEEL STRESSES-CONNECTIONS

5. Stress Mode—Gravity Connections

Maximum allowable bending stresses at gravity supports shall not exceed 50% of the yield stress (18,000 for A36 steel). All other allowable stress to be in accordance with AISC "Manual of Steel Construction."

6. Stress Mode—Retention Connection (Wind loads and seismic loads)

All allowable stresses to be in accordance with AISC "Manual of Steel Construction."

7. Stress Mode—Frames for Preassembly of Limestone Panels

All allowable stresses to be in accordance with AISC "Manual of Steel Construction."

8. Stress Mode—Secondary Framing (Wind girders, braces, hangers)

All allowable stresses to be in accordance with AISC "Manual of Steel Construction."

9. Stress Mode—Stainless Steel Anchors and Devices Contained Within the Stone

Maximum allowable stresses shall be in accordance with "Stainless Steel Stone Anchors" published by the American Iron and Steel Institute (1975), except that the maximum design loads shall not exceed the values defined in Paragraph 3, Stone Stresses at Connection Points (Anchors).

10. Stress Mode—Post Tensioning Tendons and Hardware

Allowable stresses to be in accordance with recommendations of the tensioning materials supplied for the system to be used.

Damage and Repair Practices and Standards

"Repair of stone is an accepted practice and will be permitted. Some chipping is expected; repair of small chips is not required if it does not detract from the overall appearance of the work, or impair the effectiveness of the mortar or sealant. The criteria for acceptance of chips and repairs will be per standards and practices of the industry unless other criteria are mutually agreed upon by the limestone supplier and the architect."

Indiana Limestone Handbook

Damage and Repair Practices, cont'd

The handling of damage to and repair of Indiana Limestone can make the difference between a good job and a marginal one. Over the years, limestone fabricators have developed handling methods which reduce the incident of damage in the mills; where damage does occur, and is judged to be repairable, it is industry practice to make the repair and ship the affected stone.

Damage occurring in transit, in the unloading/stacking/installation process, can usually be repaired satisfactorily by masons on the job, often using materials supplied by the stone fabricator.

The Indiana Limestone Institute recommends that small chips and snips be left alone. Usually they will not detract from the appearance of the finished work, especially if they are not at or near eye-level.

Larger chips may be repaired using cementitious materials made for the purpose. This is the kind of material ordinarily used by the fabricators. Skillfully placed, these repairs are nearly invisible, and are suitable for use at a building's upper areas, or those areas not seen at close range.

When the chip can be saved, it is usually possible to replace it using either a thermo-setting resin adhesive, or cyanoacrylate "super-glue."

If the chipped area is larger, or if it is in a critical location, a "dutchman" can usually maintain the stone's usefulness. This is a separate piece of stone cut to fit tightly in the squared-up void.

Broken corners can usually be repaired satisfactorily using thermo-setting adhesives. Occasionally, depending on the location of support surfaces in relation to the damage, dowels, plates or angles may be required in addition. The resulting hair-line joints are ordinarily not objectionable, and such repairs are structurally sound if correctly done.

Cracked stones are occasionally repairable, although when a stone shape has been so severely shocked as to develop a crack, its integrity may be suspect. Stones mounted to frames which resist both gravity and lateral loading are often the exceptions to this caution, depending on how the stones are affixed to the frames. This fact suggests that repairs to cracked stones may involve the addition of metal framing. Thermo-setting resins are the repair material of choice here.

Reasonable care in handling will reduce or eliminate damage to Indiana Limestone. Most stone shipments arrive at the site in good order, and by far the majority of stones reach their final position in the building with no damage. For trouble-free projects, contractors are urged to follow the handling instructions listed in ILI's publication, The Contractors Handbook on Indiana Limestone.

Where repair is seen as necessary, a booklet entitled Repairing Indiana Limestone can be helpful. Copies are available from ILI or its member companies.

Indiana Limestone will give the greatest satisfaction when it is handled as carefully as marble, aluminum or other metal panels, granite, glass, slate, or any other material which provides a finished surface when it arrives at the job.

Anchors and Supports

Occasionally the terms "anchor" and "support" are confused or misused. This paper is intended to clarify these terms, and their meanings.

The term "support" refers to any material or device which holds or

supports stone due to gravity loads. Examples of this condition are concrete haunches at grade or floor slab, metal clip angles, metal plates, or other stones.

The term "anchor" or "tie-back" refers to a (usually) metal item—dowel, strap, disk or other shape, which holds stone vertical or plumb, and is required to resist only lateral loads or horizontal loads.

Typically, an anchor or tie-back will be embedded in a slot or other sinkage in the stone. Where such embedded condition exists, the anchors in question must be of stainless steel or other noncorrosive material.

A common detail places a rod or blade at the toe of a gravity support (angle or plate) to prevent the stone from slipping or tilting at its base. Such a rod or blade is, actually and technically, a tie-back or anchor, and should be of stainless steel. The angle to which it is attached need not be stainless, but should be protected against rust. (ILI will comment on that procedure to inquirers.)

Among the few exceptions to these rules are the anchors used as gravity supports in soffit design, and the anchors which resist the shear loads associated with coping stones on the raked angle of a gabled roof. These appliances take the shape of anchors, but are so used that they resist gravity loads for these specialized stone applications.

Another example of the use of anchors as supports is the orientation of expansion bolts or other expanding appliances so that they carry gravity loads. (Please note that ILI recommends extreme caution in the use of expansion bolts as gravity supports. Such usage requires careful engineering analysis of the loads, conditions and safety factors required.)

Water Repellents

Exterior water repellents intended for application to vertical, above-grade, masonry walls are, generally, clear liquids of low viscosity. Their chemical makeup allows them to be absorbed by masonry substrates, leaving the surface essentially unchanged in color or texture. The active ingredients in water repellents are intended to be deposited in the pores of the substrate while not closing or blocking them, so that moisture vapor can pass from within the wall, but liquid moisture is not absorbed at the surface. Water repellents should reduce the adherence of dirt to building walls because they render the wall less absorptive. They should reduce or eliminate a "wet look" in rainy weather. They should reduce humidity in cavity walls. An effective water repellent will create these effects without altering the color of the substrate, and without creating a shine, or sheen.

In common usage, water repellents are sometimes called sealers, or waterproofers, or dampproofers. These misnomers are confusing; worse, they tend to instill a false sense of security in users. Water repellents will not render a wall waterproof, nor will they "seal" it. Waterproofers or sealers are by definition coat-formers; they change the color and texture of the substrate. Ideally, a masonry wall treated with a water repellent should not differ in appearance, during dry weather, from a similar, untreated wall.

Water repellents are not waterproof. They will not bridge gaps in mortar or sealant joints. Their use is not a fail-safe for poor mortar practice, nor a substitute for dampproofing. Water repellents have been suspected of contributing to surface scaling in some cases. It is possible that a water repellent allowing vapor transmission may reduce the rate of transmission compared to identical, untreated, substrates.

Water repellents should be applied only on completed walls, with mortar or sealant joints in place. They should not be applied over wet or stained stones, nor to stone backs, nor stones under grade.

Good workmanship is essential in the application of water repellents. As a class, the materials tend to be labor-sensitive; substrate condition, weather condition, application tool, flow rate, etc., should all be in accordance with manufacturers' instructions.

ILI does not recommend specific types or brands of water repellents. Product types including silicones, stearates, acrylics, silanes, and siloxanes have all been used with apparent success on Indiana Limestone. ILI does recommend that (1) stone samples be treated on only one-half their surface for initial evaluation; (2) manufacturers provide statements on both vapor transmission and guarantee; and (3) that applicator and manufacturer agree on the condition of the wall and the weather prior to application.

An understanding of probable retreatment costs, probable length of time until retreatment may be needed, and alternatives to retreatment should be part of the consideration of water repellents.

ILI will respond to requests for further information on this subject.

Stone Handling . . . Lifting with Lewis Pins

Lewis pins are time-honored devices for handling stones. Their use dates from a period when stone shapes tended to be more blocky than the thinner panel shapes now common. As stone thickness is reduced, lewis pins tend not only to be less reliable, but to be dangerous in the absolute sense, especially when misused.

Stone fabricators seldom use lewis pins in their own handling practice. Pins may be used in quarry operations, but even there, more reliable methods are favored. Except in rare instances, pins and other lewis devices are not suitable for contemporary limestone usage.

The accompanying table is based on tests designed by ILI and Indiana Geological Survey. The values shown are failure loads (P), in pounds. They are the value at which the test was terminated because significant fractures appeared around the pin holes, or pins deformed, or other condition dictated the termination of that particular test. These values are not factored for safety. As shown by the table, performance is affected by the angle at which the pin-hole is drilled.

Assuming properly sized and placed lewis pins for a particular lift, observe the following list of cautions:

- NEVER lift stones with lewis pins—or with ANY device—unless safety slings or other fail-safe devices are in place.
- NEVER use lewis pins in stones less than 3" thick for lifts of any description.
- NEVER use lewis pins to raise stone panels to the vertical from the horizontal, or from an edge-upward, stacked position. Slings or cradles are an absolute must for this procedure. Otherwise, pin pressure against the stone's front or back face may break it out.
- NEVER allow stones to remain suspended from lewis devices—or ANY lifting device—for longer than is necessary to transport the load from its place in the stack to its place in the wall. If work stoppage occurs, and the stone cannot be positioned for any reason, SET THE LOAD DOWN.

- NEVER transport stones suspended from lewis devices—or ANY lifting device—over areas where personnel are located or may appear. DO NOT allow personnel to pass under stones so suspended. If it is necessary to pass the load over scaffolds, CLEAR THE SCAFFOLDS of all personnel during the lift.

- NEVER bump stone being lifted by ANY device.

- LIMIT YOUR USE OF LEWIS DEVICES to those few instances in which there is no safer way to make the lift.

This table shows the loads at which lifting tests failed. It is not intended as a guide to proper handling with lewis pins, nor are specifications presented as correct for the purpose. Such intent should not be inferred. ILI includes this table solely for information, to give users a comparison for their own calculations when using lewis pins. Users must assume all responsibility for any procedures based on this table, and on the use of lewis and other lifting devices.

FAILURE LOADS (P)

| Pin Size | Hole Diam | Hole Angle (A) | Max. Load at Fracture or Pin-Bend |
|---------------|-----------|----------------|-----------------------------------|
| 1" x 6" | 1-1/4" | 18-20 deg. | 12,300 lbs. |
| do. | do. | 25-30 deg. | 10,400 lbs. |
| 3/4" x 5 1/2" | 7/8" | 25 deg. | 7,660 lbs. |
| 1/2" x 5" | 5/8" | 25 deg. | 3,500 lbs. |

The values shown here are actual failure loads of specific stones and rigging arrangements. Other stones and arrangements tested in the same manner may not produce the same failure values. A generous safety factor MUST be applied to failure loads when determining safe lifting capacities.

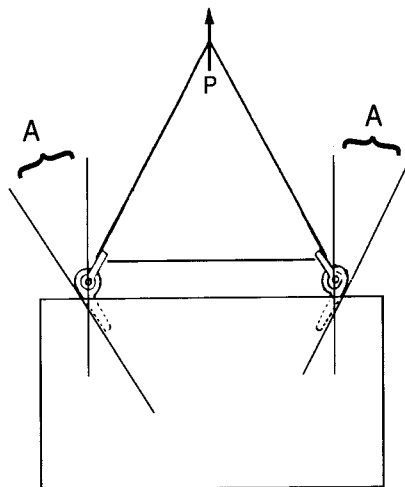

**ALL THREE SIDES OF TRIANGLE
SHOULD BE EQUAL**



Indiana Limestone Institute of America, Inc.

Suite 400

Stone City Bank Building

Bedford, Indiana 47421

812/275-4426

www.iliai.com

Indiana
Limestone
Institute

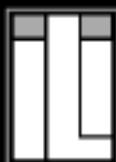

The coordinating agency
for information, education,
and technical data for
Indiana Limestone, the
Nation's Building Stone.